

Numark[®]

Professional Disc Jockey Products

EM360

PROFESSIONAL DJ EFFECTS MIXER
With KAOSS* Pad Multi-effects Processor

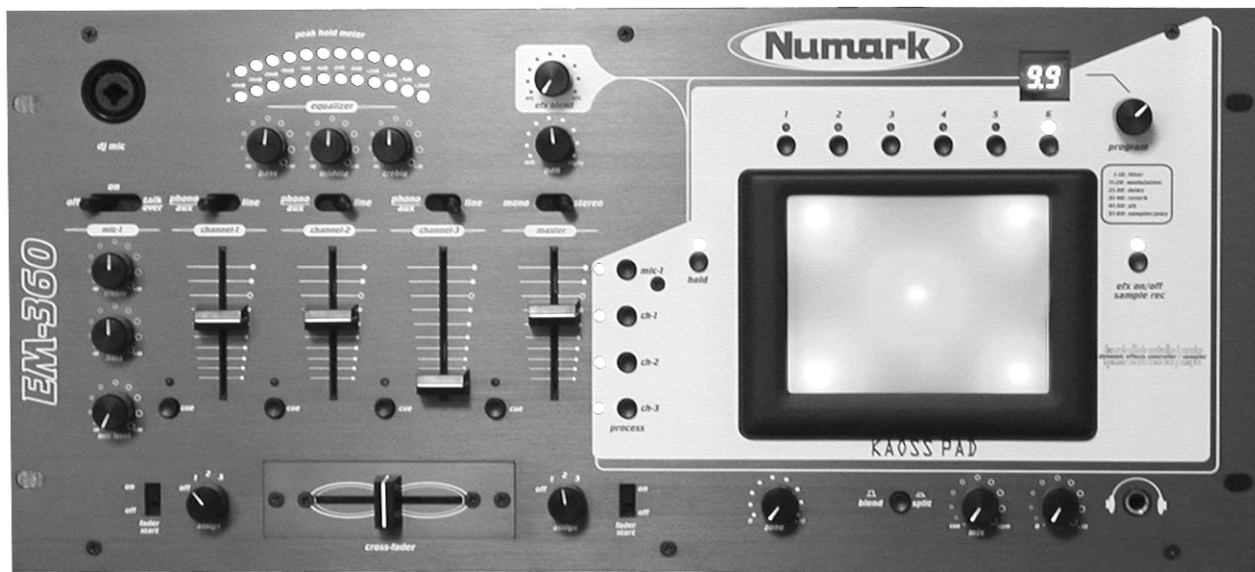

Owner's Manual

*KAOSS technology under license from KORG

©2000 **Numark** Industries

<http://www.numark.com>

Safety Information



CAUTION
RISK OF ELECTRIC SHOCK
DO NOT OPEN



CAUTION: TO REDUCE THE RISK OF ELECTRIC SHOCK DO NOT REMOVE ANY COVER. NO USER-SERVICEABLE PARTS INSIDE. REFER SERVICING TO QUALIFIED SERVICE PERSONNEL ONLY.

The lightning flash with arrowhead symbol within the equilateral triangle is intended to alert the user to the presence of un-insulated "dangerous voltage" within the product's enclosure that may be of sufficient magnitude to constitute a risk of electric shock.

The exclamation point within the equilateral triangle is intended to alert the user to the presence of important operating and maintenance (servicing) instructions in the literature accompanying this appliance.

CAUTION

FOR USA & CANADIAN MODELS ONLY
TO PREVENT ELECTRIC SHOCK DO NOT USE THIS (POLARIZED) PLUG WITH AN EXTENSION CORD, RECEPTACLE OR OTHER OUTLET UNLESS THE BLADES CAN BE FULLY INSERTED TO PREVENT BLADE EXPOSURE.

SAFETY INSTRUCTIONS

- a) Read Instructions - All the safety and operating instructions should be read before this product is connected and used.
- b) Retain Instructions - The safety and operating instructions should be kept for future reference.
- c) Heed Warnings - All warnings on this product and in these operating instructions should be followed.
- d) Follow Instructions - All operating and other instructions should be followed.
- e) Water and Moisture - This product should be kept away from direct contact with liquids.
- f) Heat - Avoid placing this product too close to any high heat sources such as radiators.
- g) Ventilation - The appliance should be situated so that its location or position does not interfere with its proper ventilation. For example, the appliance should not be situated on a bed, sofa, rug, or similar surface that may block the ventilation opening; or, placed in a built-installation, such as bookcase or cabinet that may impede the flow of air through the ventilation openings.

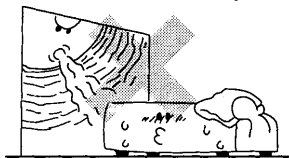
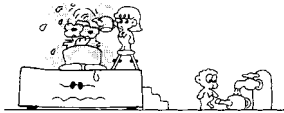

- h) Power Sources - This product should be connected to a power supply only of the type described in these operating instructions, or as marked on the unit.
- i) Power Cord Protection - Power supply cords should be routed so that they are not likely to be walked upon or pinched by items placed on or against them. When removing the cord from a power outlet be sure to remove it by holding the plug attachment and not by pulling on the cord.



- j) Object and Liquid Entry - Take care that objects do not fall into and that liquids are not spilled into the inside of the mixer.
- k) Cleaning - The appliance should be cleaned only as recommended by the manufacturer.
- l) Non-use Periods - The power cord of the appliance should be unplugged from the outlet when left unused for long periods of time.
- m) Damage Requiring Service - Never attempt to make any adjustments or repairs other than those described in this manual. Only qualified personnel should service this product. If you have any questions about service please contact Numark at the number(s) shown on the back cover of this manual.

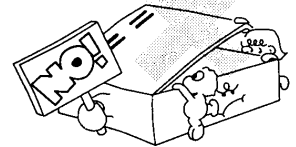

- n) Grounding or Polarization - Precautions should be taken so that the grounding or polarization means built into the CD player is not defeated.
- o) Internal/External Voltage Selectors - Internal or external voltage selector switches, if any, should only be reset and re-equipped with a proper plug for alternative voltage by a qualified service technician. Do not attempt to alter this yourself.

WARNING: To reduce the risk of fire or electrical shock, do not expose this appliance to rain or moisture. Electrical equipment should NEVER be kept or stored in damp environments.

SERVICE INSTRUCTIONS

- Disconnect power cord before servicing
- Replace critical components only with factory parts or recommended equivalents
- For AC line powered units - Before returning repaired unit to user, use an ohmmeter to measure from both AC plug blades to all exposed metallic parts. The resistance should be no more than 100,000ohms.

Numark[®] EM360 PROFESSIONAL DJ EFFECTS MIXER

With KAOSS PAD Multi-effects Processor

CONGRATULATIONS!

You have purchased the **EM360** Stereo Effects Mixer by **Numark**. It is the first DJ mixer with a completely interactive, real-time effects processor. This one of a kind DJ product boasts all of the qualities that you have come to expect from a **Numark** mixer plus, it features a built in **KAOSS PAD***. This piece of equipment literally puts effects processing at the DJ's fingertips. The **EM360** is easily suited for mobile or installation use. Special features found on this product are six line inputs, balanced outputs, and fader start. The fader start feature is designed to work with **Numark's** Fader Start CD players as well as its other popular CD players. The **KAOSS Pad*** effects processing unit lets the DJ control his choice of up to sixty effects programs in real-time. The effects unit allows for sampling functions, parameter controls, and MIDI compatibility.

Thank you for purchasing NUMARK products!

Mixer Features:

- Six line, three phono, one mic input
- Front panel Neutrik[™] mic input with:
Bass, Treble and Talk-over control
- Master with Balanced outputs
 - 3-band EQ and Pan control
- Completely assignable and replaceable cross-fader
- Fader start
- Zone outputs
- Split/blend headphone cueing

KAOSS PAD* Features:

- Real-time effects processing
 - X-Y touch sensitive pad
 - Separate parameter controls
 - Sixty "effects programs"
 - Hold switch to lock in settings
 - Sampler (5 seconds at 48 kHz)
 - MIDI compatibility
 - 100% digital processing
- *KAOSS technology under license from KORG*

Table of Contents

Safety Measures	2	KAOSS Effects	8
Introduction	3	MIDI Implementation	9
Registration	3	Specifications	10
Description of the Features	4	Block Diagram	11
Quick Setup Diagram	7	Warranty	12

Product Registration

Please record the serial number of your unit as shown on the back of the chassis as well as the name of the dealer from whom you purchased the unit. Retain this information and your original purchase receipt for your records. Please return the enclosed warranty card to register your unit with us.

MODEL: _____

PURCHASED FROM: _____

SERIAL NUMBER: _____

DATE OF PURCHASE: _____

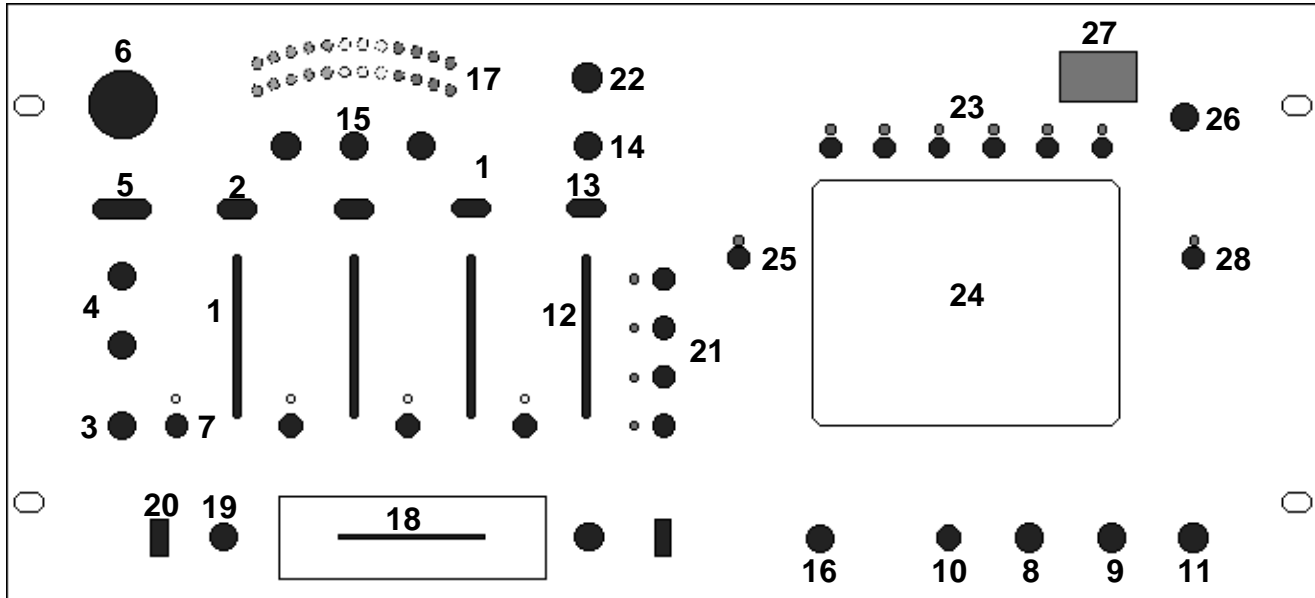
MIXER FEATURES**INPUTS**

- Input faders** - control individual source levels in the mix.
Note: Never use spray cleaners on the slide controls. Residues cause excessive dirt build-up and this will void your warranty. In normal use slide controls can last for many years. If they malfunction (usually because of a dirty or dusty environment) consult a professional technician.
- Input Toggle Switches** - select which source will be live to that channel based on what you have connected to the rear panel input section.

MICROPHONE

- Mic Gain Control** – controls the **DJ Mic** volume for the Neutrik™ “Combo” connector on the front panel.
- Treble and Bass Controls** – for fine-tuning the tone of your voice through the sound system. The controls are detented for setting tone “flat”.
- Mic Off/On/Talkover Switch** – controls DJ Mic. **Talkover** turns down the input level of your music –12dB for easy understanding of announcements.
- Neutrik™ “Combo” connector** - allows connection of either a 1/4” jack or an XLR jack. This is ideal for connecting an XLR gooseneck directly into the mixer.

HEADPHONE CUEING

- Channel Cue Assign** - are used to route Pre Fader Level (PFL) channel audio to the **Monitor Section**. The channel faders do not control the **Cue** volume.
- Headphone Mix** - controls the mix of PFL and PGM signals to your headphones. When the slider is moved to the left, all you will hear is the cue source. When the slider is all the way to the right, you will hear what is playing through the master output. By blending, beats can be matched exactly and segues can be smooth when a song is cued.
- Headphone Level** – adjusts cue volume.

- Split/Blend Cue** – controls how PFL and Program audio are sent to your headphones. In **split** mode, the PFL audio can be heard in your left ear and PGM audio can be heard in your right ear. In **blend** mode, both PFL and PGM can be heard in both ears.
- Headphone output** – for your 1/4” or 1/8” headphones.

OUTPUTS

- Master Fader** – controls the overall output level.
- Stereo/Mono toggle** - adjusts the **Master** output for stereo or mono operation.
- Panning** – adjusts the balance of right to left audio.
- 3-Band Stereo Equalizer (EQ)** - compensates for differences in source material sound quality. In ultra-compact mobile systems this EQ can be used to tailor the sound to the acoustical requirements of the room.
- Booth/Zone Fader** - controls speaker volume for a remote zone or booth monitors.
NOTE: This can also be used to supply line level audio to a lighting controller or to lights that are sound activated.
- Stereo Auto Peak Hold Level Indicator**- quickly and accurately tracks level of audio output. The red LEDs for +3dB, +5dB and +8dB hold program peaks for a second or two. With peak metering, it's OK to be “in the red” as long as +5dB or +8dB aren't constantly lit. **When using as a master output meter**, set the crossover, equalizer and power amp inputs to avoid distortion at each step in the audio chain. Proper attention to the peak meter results in the punchiest possible sound without audible distortion.

CROSSFADER

18. **Replaceable Crossfader** - achieves clean segues between the two input channels selected by the Crossfader Assign.

*Note: The crossfader is a user replaceable item and subject to wear. **Excessive force can wear out the fader quickly.** This is not a warranted item. In case of failure. Simply unscrew the two large screws that hold it in place, lift it out and disconnect its cable. Re-attach the new crossfader and screw the mounting plate back onto the unit - you're back in business!*

19. **Crossfader Assign Knob** - determines which input channel will be heard when the crossfader is moved towards the knob. With the crossfader centered, both assigned channels are live. Use the crossfader for fast and seamless segues from one selected channel to the other.
20. **Fader Start** – activates the crossfader to send play and cue commands to your auto-start **Numark** CD player or other popular brand. For fader start, attach your mixer to a remote start CD player using industry standard 1/8"(3.5mm) cables. When you move the crossfader toward the active channel, the attached CD player will start. When it is moved away, that side will cue (similar to pressing the cue button).

KAOSS PAD*

21. **Process buttons** – send post channel fader audio to the KA OSS PAD for processing.
22. **Process Blend Control** – mixes processed (efx)-wet audio with unprocessed (src)-dry audio. Use this in conjunction with the KA OSS pad to reach desired effects.
23. **Preset Program keys (1–6)**- You can assign programs to keys 1–6 for convenient selection.

Program assignment:

- a) Press one of the PROGRAM MAP keys.
 - b) Use the PROGRAM knob to select the program that you wish to assign. If you wish to memorize the HOLD setting, turn the HOLD switch to ON after selecting the program, and touch the touch panel to specify the position.
 - c) Press and hold the PROGRAM MAP key you pressed in step 1 for approximately two seconds.
24. **Touch panel**- You can control the sound by using your finger to rub or tap (strike lightly) this panel. **Never press down too hard on the touch panel, or place a heavy object on it. Rough handling can cause it to crack or break. Rubbing or pressing the touch panel with a sharp object can scratch it, so only use your finger to operate it.** If cleaning is necessary, wipe only with a soft dry cloth. Using solvents such as thinner may melt the surface of the touch panel. *Note: Affix the included protective label to extend product life.*
25. **Hold Switch**- When this switch is ON, the current state of the effect will be maintained even if you remove your finger from the touch panel.
26. **Program Knob**- Use this knob to select programs (1–60). Please see page for a complete listing of effects.
27. **Program/Location Display**- This shows either the currently selected program number or the location of the point that you touched on the touch panel, depending upon mode.

- When selecting a program: the program number (1–60) will be displayed.
- When operating the touch panel: the position you touched (1.1–9.9) with 5.5 being the center) will be displayed.

Example display: **3.8**

vertical position is (3) / horizontal position is (8)

If you select a program that has a Hold On setting, the program number will be displayed, and then the position that is being held will be displayed.

28. **EFX ON/OFF / Sample Record switch**- This can be used to switch between the effect sound and the direct (unprocessed) sound, or to record a sample.

When sampling this button lets you record a phrase that you hear and then play it back by operating the touch panel.

Use the following procedure to record and playback samples.

- Using the PROGRAM knob or the PROGRAM MAP keys, select a sample/play effect (program numbers 51–60). The REC switch LED will blink, and the KA OSS PAD will be in record-ready mode. At this time, the sound will be output without any change.
- Press the REC switch to begin recording.
- Press the REC switch once again to stop recording. The REC switch LED will light. Even if you do not press the REC switch, recording will end automatically when the maximum recording time has elapsed. (The maximum recording time will depend on the program.)
- Operate the touch panel to playback the recorded phrase. The sound will change depending on the position where you touch the panel. The way in which the sound changes will depend on the program.
- To re-record, press the REC switch again. The previously recorded phrase will be erased, and a new phrase will be recorded.

If you change programs to a non-sample program, the recorded phrase will be erased.

*KA OSS technology under license from KORG

Numark- The Leader in DJ Technology

REAR PANEL FEATURES

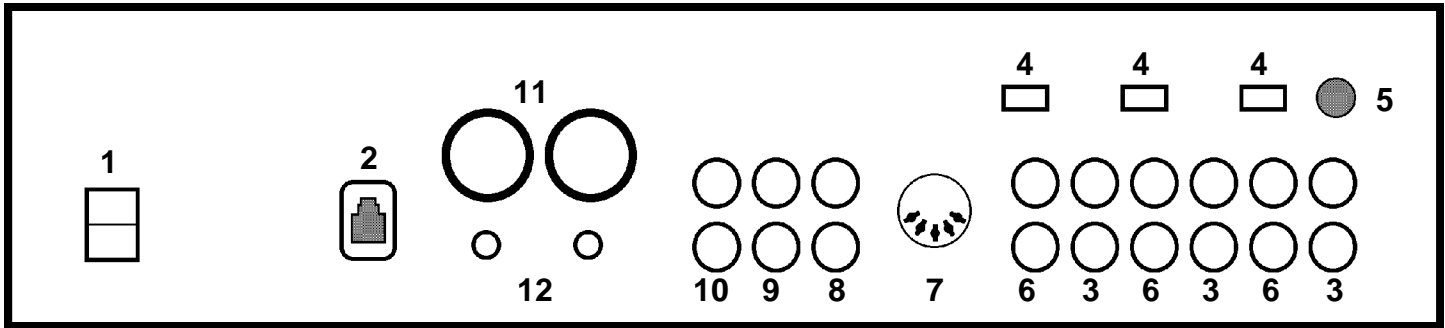

1. **Power Switch** – To turn unit on *after* you have turned on all input devices and *before* you turn on any devices attached to the output.
2. **Power Supply Input** - To plug your power adapter in before switching on power. See safety precautions on page 3 for proper treatment of power.
3. **Phono/Auxiliary Inputs** – Plug your turntables or line device in here. Select the AUX/PHONO switch (6) to the desired input.
4. **Phono/Auxiliary switch** – Select the appropriate position for your input device. With phono selected the input signal is fed directly to the PRO SM-1's high-quality RIAA phono pre-amplifiers so use this input only for turntables. Line level sources will overload the sensitive phono pre-amps. Switch this over to the AUX position for line devices such as CD players and Tape decks.
5. **Ground lug** - Use these connections with your turntables' grounding cable to avoid signal hum.
6. **Line Inputs** - To connect stereo audio from HiFi VCRs, cassette and reel-to-reel tape decks, DAT machines, CD players, laser discs, tuners, even synthesizers or other mixing consoles.
7. **MIDI Output** – Attach Midi output to external processors to be controlled by the KAOSS Pad. See page 9 for details on signal output.
8. **Record Outputs** – Unbalanced output used to send the output of the program to any connected recording device.
9. **Zone/Booth Output** - Unbalanced output controlled by Zone Level control on the face panel for extra speakers, lighting, or recording your mix.
10. **Unbalanced Main Outputs** – Unbalanced program output controlled by the Master fader knob.
11. **Balanced Outputs** - These XLR Stereo Main Outputs are reliable Balanced connectors controlled by the Master fader knob. Power transformers and other devices, which cause magnetic fields, can induce hum in audio cables. This can be best resolved by using balanced lines where inputs and outputs permit. Balanced lines are also the most effective means of reducing or eliminating RF or radio frequency" interference".
12. **Fader Start Connector** – to attach your mixer to a remote start equipped **Numark** CD player using industry standard 1/8"(3.5mm) cables.

NOTE: Plug mono audio sources into both Left and Right inputs using a "Y" cable connector.

QUICK SETUP DIAGRAM

VERY IMPORTANT: Please read this entire manual before connecting this unit to your system

For optimum performance:

- Always make sure that AC power is OFF while making any connections.
- Use appropriate cables throughout your system. Do not use excessively long cables (i.e. over 50ft/14m) Be sure plugs and jacks are tightly mated. Loose connections can cause hum, noise or intermittence that could easily damage your speakers. Make the input and output connections with readily available low-capacitance stereo cables. Quality cable makes a big difference in audio fidelity and punch. See your Numark dealer or an electronics or audio specialist store if you are not sure which cables to get.
- ALWAYS remember: "TURN AMPS ON LAST AND OFF FIRST". Begin with master faders or volume controls on minimum and the amplifier gain/input control(s) down. Wait 8 to 10 seconds before turning up the volume. This prevents transients, which may cause severe speaker damage.
- Use restraint when operating controls. Try to move them slowly. Rapid adjustments could damage speakers due to amplifier clipping. Avoid amplifier "clipping" at all costs: this occurs when the red LEDs (usually on the front panel of most professional power amplifiers) start flashing. "Clipping" is when the power amplifier is distorting and working beyond it's limits. Amplifier distortion is THE major cause of speaker failure.

Study this setup diagram. Make sure all faders are at "zero" and all devices are off. First, connect all input sources and processors. Next, connect your microphone and monitor headphones. Finally, connect the stereo outputs to the power amplifier(s) and/or audio receivers such as tape decks. Plug your mixer into AC power. Now you are ready to switch everything on.

IMPORTANT: Always switch on your audio input sources such as turntables or CD players first, then your mixer, and finally any amplifiers. When turning off, always reverse this operation by turning off amplifiers, then your mixer, and then input devices.

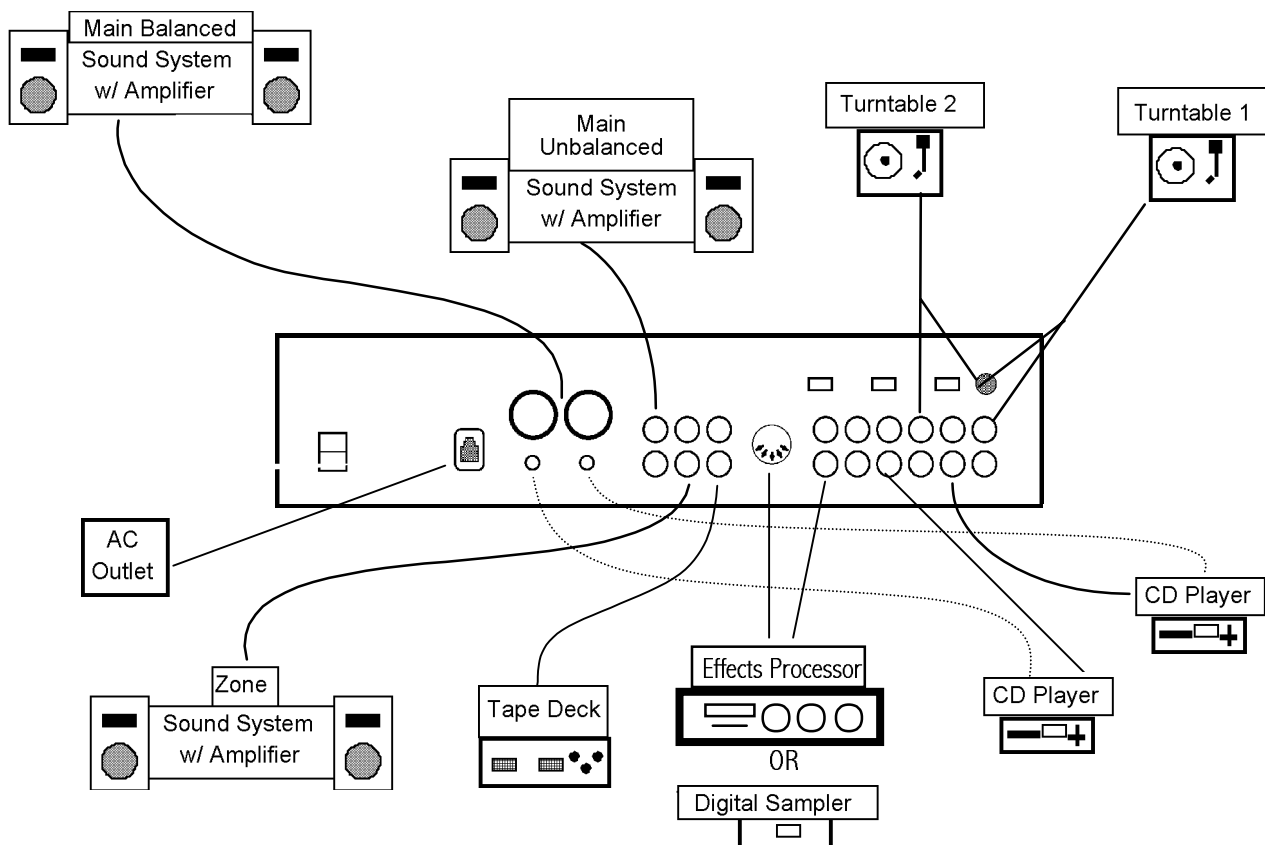

Numark - The Leader in DJ Technology

KAOSS PROGRAM EFFECTS

Effect program control parameter list

NO	EFFECT	X (horizontal position)	Y [-Y, +Y] (vertical position)	Comment
1	LOW PASS FILTER	FREQ	DI/FX BALANCE, RESONANCE	Rub slowly
2	LOW PASS FILTER	FREQ	RESONANCE	Rub slowly
3	WAH FILTER	FREQ	DI/FX BALANCE, LFO DEPTH	Rub slowly
4	DIST+VOICE FILTER	FREQ	DIST GAIN	Rub fast with beat
5	DIST+L.P FILTER	FREQ	DIST GAIN	Rub fast with beat
6	DIST+L.P FILTER	FREQ	RESONANCE	Good for voice (Mic)
7	PAN+FILTER	PAN	FREQ	Rub (1.1 <-> 9.9)
8	DIST+FILTER	FREQ	FX BALANCE, DIST GAIN	Rub fast with beat
9	ISOLATOR TYPE FILTER	FREQ	NO ASSIGN	For "Bass Cut"
10	DISTORTION	GAIN	LEVEL	For "HOLD" use
11	PHASER	FREQ (MANUAL)	DI/FX BALANCE, RESONANCE	Rub slowly
12	PHASER	LFO SPEED	FREQ (MANUAL)	Rub slowly
13	LFO WAH	LFO SPEED	FX BALANCE	Rub fast with beat
14	STEP PHASER	LFO SPEED	MOD STEP	Rub slowly
15	DIST+PHASER	LFO SPEED	DIST GAIN	Rub slowly
16	MANUAL FLANGER	DELAY TIME	RESONANCE	Rub very slowly (L <-> R)
17	MANUAL FLANGER	DELAY TIME	RESONANCE	Rub very slowly (L <-> R)
18	PITCH SHIFT	Lch PITCH	Rch PITCH	Rub
19	TREMOLO	LFO SPEED	LFO DEPTH	Rub
20	STEP PHASER	LFO SPEED	RESONANCE	Rub slowly
21	TAPE ECHO	TIME	FX LEVEL, FEEDBACK	Rub (Bottom <-> Top)
22	DELAY	TIME	FX LEVEL	Tap with snare drum
23	DELAY	TIME	FX LEVEL, FEEDBACK	Rub
24	STEREO TAPE ECHO	TIME	FREQ	Rub or tap
25	MEDIUM DELAY	FEEDBACK	FX LEVEL	Rub fast
26	LONG DELAY	FEEDBACK	FX LEVEL	Rub fast
27	X DELAY	FEEDBACK	FX LEVEL	Rub or tap
28	TALK FILTER+DELAY	FILTER FREQ	DELAY LEVEL	Rub with beat
29	DIST+FILTER+DELAY	FREQ	DELAY LEVEL	Rub with beat
30	DELAY+FILTER FOR DUB	TIME	FREQ	Rub or tap
31	REVERB (HALL)	LOW CUT	FX LEVEL	Tap with snare drum
32	GATE REVERB (HALL)	LOW CUT	FX LEVEL	Tap with snare drum
33	REVERB (PLATE)	LOW CUT	FX LEVEL	Tap with snare drum
34	GATE REVERB (ROOM)	LOW CUT	FX LEVEL	Tap with snare drum
35	DELAY+REVERB	DELAY LEVEL	REVERB LEVEL	For "HOLD" use
36	DELAY+REVERB	DELAY TIME	FX LEVEL	For "HOLD" use
37	TALK FILTER+REVERB	FILTER FREQ	FX LEVEL	Rub fast with beat
38	DIST+FILTER+REVERB	FILTER FREQ	REV LEVEL+RESONANCE	Tap with snare drum
39	REVERB+PAN	PAN	FX LEVEL	Rub for panning
40	REVERB	REVERB TIME	FX LEVEL	For "HOLD" use
41	STEP MODULATION	MOD DEPTH	FX LEVEL	Rub slowly
42	RING MOD+FILTER	RING FREQ	FILTER FREQ	Tap at random
43	RING+TALK MOD	MOD SPEED	RING FREQ	As you like
44	SPECIAL ECHO	TIME	FX LEVEL	Rub at random
45	RING+DELAY	TIME	RING+DELAY BALANCE	Rub at random
46	DELAY+TREMOLO	TIME+LFO SPEED	DLY+TREM X-FADE	Rub in circle
47	3D PAN	PAN (L/R)	NEAR/FAR	Rub for panning
48	VIBRATE	SPEED+DEPTH	FX BALANCE	Rub (Bottom <-> Top)
49	STEP FLANGER	FREQ (MANUAL)	FEEDBACK	Rub slowly
50	STEP PHASER	LFO SPEED	FX LEVEL	Rub slowly
51	SAMPLE/PLAY1	LOOP TIME	FX LEVEL	Tap for playback
52	SAMPLE/PLAY2	FORWARD/REVERSE	FX LEVEL	Rub like scratch
53	SAMPLE/PLAY3	TIME STRETCH	FX LEVEL	Rub for "TIME STRETCH"
54	SAMPLE/PLAY1 (*AUTO REC)	LOOP TIME	FX LEVEL	Tap for playback
55	SAMPLE/PLAY2 (*AUTO REC)	FORWARD/REVERSE	FX LEVEL	Rub like scratch
56	SAMPLE/PLAY3 (*AUTO REC)	TIME STRETCH	FX LEVEL	Rub for "TIME STRETCH"
57	SAMPLE/PLAY1 (DIRECT MIX TYPE)	LOOP TIME	FX LEVEL	Tap for playback
58	SAMPLE/PLAY2 (DIRECT MIX TYPE)	FORWARD/REVERSE	FX LEVEL	Rub like scratch
59	SAMPLE/PLAY1+PAN	PAN	LOOP TIME	Tap (L <-> R)
60	SAMPLE/PLAY2+PAN	PAN	FORWARD/REVERSE	Tap (L <-> R)

*(AUTO REC): After you press the REC switch, recording will begin automatically when sound is input. When you press the REC switch once again, recording will end. (This is convenient when recording your voice from a mic.)

MIDI FUNCTIONS

With the factory settings, each operation will transmit the following MIDI messages.

Operation	MIDI messages transmitted	Transmission on/off
Touch panel X-axis	Pitch bend messages	En 00 00–En 7F 7F
	Effect Control 1 message (CC#12)*	Bn 0C 00–Bn 0C 7F
Touch panel Y-axis	Modulation 1 Depth message (CC#1) Y = 5–9	Bn 01 00–Bn 01 7F
	Modulation 2 Depth message (CC#2) Y = 5–1	Bn 02 00–Bn 02 7F
Touch panel X+Y axis (gpn)	Effect 3 Depth message (CC#93)*	Bn 5D 00–Bn 5D 7F
Touch panel on/off	Effect 2 Depth message (CC#92)*	Bn 5C 7F/Bn 5C 00
FX ON/OFF	Effect 4 Depth message (CC#94)*	Bn 5E 7F/Bn 5E 00
Change Program	Program Change message (1–60)	Cn 00–Cn 38

*The MIDI messages that are transmitted can be selected in the range of CC#1–CC#31 and CC#64–CC#95. In MIDI Edit mode (“MIDI transmission settings”) you can hold down the corresponding switch and rotate the PROGRAM knob to select the desired control number.

A control number that has already been assigned cannot be selected in duplicate.

MIDI transmission settings

When you press the six PROGRAM MAP keys simultaneously, you will enter MIDI Edit mode. If you then perform no operation for approximately 10 seconds or if you touch the touch panel, you will return to normal mode.

In MIDI Edit mode, you can use the following operations to change the MIDI transmission settings.

- PROGRAM knob: Set the MIDI transmission channel (1–16)
- PROGRAM MAP keys, FX ON/OFF, HOLD switches: Turn transmission on/off for each type of MIDI message (refer to “Transmission on/off” in the above table).

Precautions with the KAOSS PAD

Usage -Never press down too hard on the touch panel, or place a heavy object on it. Rough handling can cause it to crack or break. Rubbing or pressing the touch panel with a sharp object can scratch it, so only use your finger to operate it. If cleaning is necessary, wipe only with a soft dry cloth. Using solvents such as thinner may melt the surface of the touch panel. *Note: Affix the included protective label to extend product life.*

Location -Using the unit in the following locations can result in a malfunction.

- In direct sunlight
- Locations of extreme temperature or humidity
- Excessively dusty or dirty locations
- Locations of excessive vibration

Interference with other electrical devices -This product contains a microcomputer. Radios and televisions placed nearby may experience reception interference. Operate this unit at a suitable distance from radios and televisions.

Handling -To avoid breakage, do not apply excessive force to the switches or controls.

Care -If the exterior becomes dirty, wipe it with a clean, dry cloth. Do not use liquid cleaners such as benzene or thinner, or cleaning compounds or flammable polishes.

SPECIFICATIONS

INPUTS:

Line: 10Kohm input impedance
110mV rms sensitivity (for 1.22V output)
Mic: 10Kohm input impedance unbalanced
1.6 mV rms sensitivity (for 1.22V output)
500mV rms max input
Phono: 47Kohm input impedance
1.8mV rms sensitivity @ 1 KHz (for 1.22V output)

OUTPUTS:

Line: 9V rms max
Headphone Amp: 1V rms watt into 16ohm

Distortion: less than 0.01%

SIGNAL TO NOISE RATIOS* (vs. maximum output):

Line: Better than 96 dB
Mic: Better than 78 dB
Phono: Better than 87 dB

*JIS - weighted

FREQUENCY RESPONSE:

Line: 20 Hz- 22k Hz ± 0.5 dB
Line: 20 Hz- 20k Hz ± 0.5 dB
Phono: ± 1 dB except for controlled attenuation of -3 dB
@ 20 Hz to reduce rumble and feedback

EQUALIZER:

± 10 dB @

KOASS PAD:

Programs: 60
Sampling length: 5 Seconds

POWER CONSUMPTION:

10 Watt typical
15 watt with full headphone output

DIMENSIONS:

480mm(W) x 220mm(H) x 95mm(D)
19" (W) x 8 3/4" (H) x 4 (D)

WEIGHT: 4 kgs, 8.5 lbs

BLOCK DIAGRAM

Numark®

Professional Disc Jockey Products

LIMITED PRODUCT WARRANTY

What is covered and for how long?

1. NUMARK INDUSTRIES LCC ("NUMARK") warrants to the original purchaser that NUMARK'S DJ mixers and amplifiers are free from defects in material and workmanship under normal use and service for the period commencing upon the date of purchase from an authorized NUMARK dealer and continuing for the following period of time after that date for (2) Years. The warranty is extended to (3) Years with the completion of the warranty card provided that the warranty card is completed and returned within (30) days from the date of purchase. All other NUMARK products are warranted for (1) Year including but not limited to CD players, CD Mix Stations, turntables, preamplifiers, beatkeepers, equalizers, microphones, headphones, and all other accessories.

What is not covered? This Limited Warranty is conditioned upon proper use of the product by the purchaser.

2. This Limited Warranty does not cover: (a) defects or damage resulting from accident, misuse, abuse, neglect, unusual physical or electrical stress, modification of any part of the product, or cosmetic damage; (b) equipment that has the serial number removed or made illegible; (c) all plastic surfaces and other externally exposed parts that are scratched or damaged due to normal use; (d) defects or damage from improper testing, operation, maintenance, installation, adjustment, or service of the mixers; (e) crossfaders.
3. What are NUMARK'S obligations? During the applicable warranty period, NUMARK will repair or replace, at NUMARK'S sole discretion, without charge to the purchaser, any defective component part of the mixer. To obtain service under this Limited Warranty, purchaser must first contact NUMARK and obtain a return authorization number ("RA#"). Purchaser must then return the mixer to NUMARK in an adequate container for shipping, accompanied by purchaser's sales receipt or comparable proof of sale showing the date of purchase, the serial number of the product, and the seller's name and address. To obtain an RA# and assistance on where to return the mixer, contact NUMARK customer service at 401-295 9000. Upon receipt, NUMARK will repair or replace the defective products. NUMARK may, at NUMARK'S sole discretion, use rebuilt, reconditioned, or new parts or components when repairing any product or replace a product with a rebuilt, reconditioned or new product. Repaired mixers will be warranted for a period equal to the remainder of the original Limited Warranty on the original mixer or for (90) days, whichever is longer. All replaced parts, components, boards and equipment become the property of NUMARK. If NUMARK determines that any mixer is not covered by this Limited Warranty, purchaser must pay all parts, shipping, and labor charges for the repair or return of such mixer.
4. What are the limits on NUMARK'S liabilities? THE WARRANTIES GIVEN IN THIS LIMITED WARRANTY, TOGETHER WITH ANY IMPLIED WARRANTIES COVERING NUMARK MIXERS, INCLUDING WITHOUT LIMITATION ANY WARRANTIES OF MERCHANTABILITY OR FITNESS FOR A PARTICULAR PURPOSE, ARE LIMITED TO THE DURATION OF THIS LIMITED WARRANTY. EXCEPT TO THE EXTENT PROHIBITED BY APPLICABLE LAW, NUMARK SHALL NOT BE LIABLE FOR ANY SPECIAL, INCIDENTAL, CONSEQUENTIAL, INDIRECT OR SIMILAR DAMAGES, LOSS OF PROFITS, DAMAGES TO PURCHASER'S PROPERTY, OR INJURY TO PURCHASER OR OTHERS ARISING OUT OF THE USE, MISUSE OR INABILITY TO USE ANY NUMARK MIXER, BREACH OF WARRANTY, OR NEGLIGENCE, INCLUDING BUT NOT LIMITED TO NUMARK'S OWN NEGLIGENCE, EVEN IF NUMARK OR ITS AGENT HAS BEEN ADVISED OF SUCH DAMAGES, OR FOR ANY CLAIM BROUGHT AGAINST PURCHASER BY ANY OTHER PARTY. THIS LIMITED WARRANTY IS THE COMPLETE WARRANTY FOR NUMARK'S MIXERS, AND IS GIVEN IN LIEU OF ALL OTHER EXPRESS WARRANTIES. THIS LIMITED WARRANTY SHALL NOT EXTEND TO ANYONE OTHER THAN THE ORIGINAL PURCHASER OF THIS PRODUCT AND STATES PURCHASER'S EXCLUSIVE REMEDY. IF ANY PORTION OF THIS LIMITED WARRANTY IS ILLEGAL OR UNENFORCEABLE BY REASON OF ANY LAW, SUCH PARTIAL ILLEGALITY OR UNENFORCEABILITY SHALL NOT AFFECT THE ENFORCEABILITY OF THE REMAINDER OF THIS LIMITED WARRANTY WHICH PURCHASER ACKNOWLEDGES IS AND WILL ALWAYS BE CONSTRUED TO BE LIMITED BY ITS TERMS OR AS LIMITED AS THE LAW PERMITS.
5. This Limited Warranty allocates risk of product failure between purchaser and NUMARK, and NUMARK'S product pricing reflects this allocation of risk and the limitations of liability contained in this Limited Warranty. The agents, employees, distributors, and dealers of NUMARK are not authorized to make modifications to this Limited Warranty, or make additional warranties binding on NUMARK. Accordingly, additional statements such as dealer advertising or presentation, whether oral or written, do not constitute warranties by NUMARK and should not be relied upon.
6. How does state law apply to this warranty? SOME STATES DO NOT ALLOW THE EXCLUSION OR LIMITATIONS OF INCIDENTAL OR CONSEQUENTIAL DAMAGES OR HOW LONG AN IMPLIED WARRANTY LASTS, SO THE ABOVE LIMITATIONS OR EXCLUSIONS MAY NOT APPLY TO PURCHASER.
7. This Limited Warranty gives you specific legal rights. You may also have other rights, which vary from one jurisdiction to another.

RETURN INFORMATION

- a) A Return Authorization number must be obtained from Numark through the address or phone numbers below.
- b) A copy of the original sales receipt must also be included for the equipment to be repaired under warranty.
- c) The faulty equipment must be packed in its original packaging.
- d) One additional outer layer of packaging must be included to ensure product safety. Failure to do so may inadequately protect the equipment in transit and, therefore, jeopardize the customer's warranty.
- e) Numark will not accept COD shipments and no call tags will be issued for merchandise return.
- f) Numark will not return repaired merchandise to customers by priority service, unless by written request at the customer's cost. Requests must be submitted in writing with merchandise returned.
- g) The defective Numark equipment should be sent, FREIGHT PREPAID with Return Authorization number clearly printed on the outer packaging and original sales receipt enclosed to:

Numark INDUSTRIES
Attention: Service Department
11 Helmsman Avenue
North Kingstown, RI 02852 USA

Phone: +1 (401) 295-9000
Fax: +1 (401) 295-5200
Web: www.numark.com