

Numark®

Professional Disc Jockey Products

CDN24 - PROFESSIONAL DUAL CD PLAYER

OPERATING MANUAL

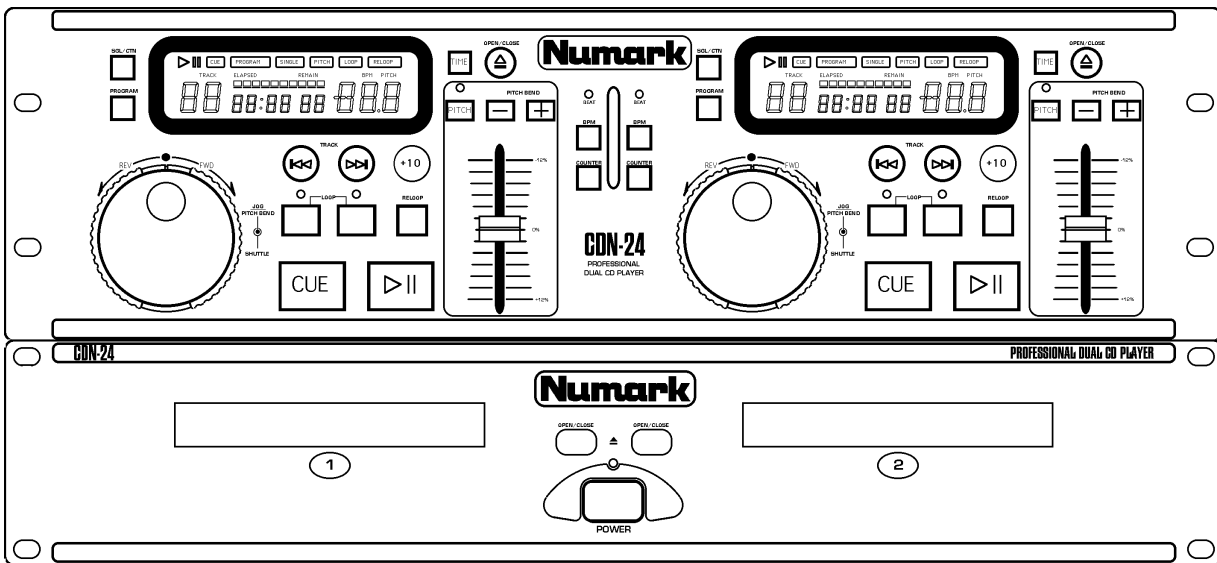

Safety Information and Product Registration

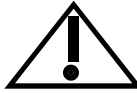
	CAUTION RISK OF ELECTRIC SHOCK DO NOT OPEN	
<p>CAUTION: TO REDUCE THE RISK OF ELECTRIC SHOCK DO NOT REMOVE ANY COVER. NO USER-SERVICEABLE PARTS INSIDE. REFER SERVICING TO QUALIFIED SERVICE PERSONNEL ONLY.</p> <p>The lightning flash with arrowhead symbol within the equilateral triangle is intended to alert the user to the presence of un-insulated "dangerous voltage" within the product's enclosure that may be of sufficient magnitude to constitute a risk of electric shock to persons.</p> <p>The exclamation point within the equilateral triangle is intended to alert the user to the presence of important operating and maintenance (servicing) instructions in the literature accompanying this appliance.</p>		

CAUTION
FOR USA & CANADIAN MODELS ONLY
TO PREVENT ELECTRIC SHOCK DO NOT USE THIS (POLARIZED) PLUG WITH AN EXTENSION CORD, RECEPTACLE OR OTHER OUTLET UNLESS THE BLADES CAN BE FULLY INSERTED TO PREVENT BLADE EXPOSURE.

SAFETY INSTRUCTIONS

1. Read Instructions - All the safety and operating instructions should be read before this product is connected and used.
2. Retain Instructions - The safety and operating instructions should be kept for future reference.
3. Heed Warnings - All warnings on this product and in these operating instructions should be followed.
4. Follow Instructions - All operating and other instructions should be followed.
5. Water and Moisture - This product should be kept away from direct contact with liquids.

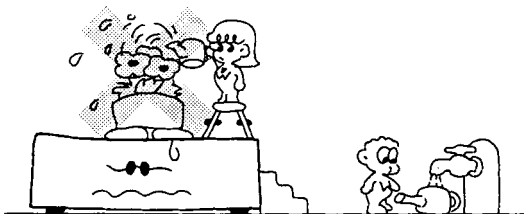

6. Heat - Avoid placing this product too close to any high heat sources such as radiators.

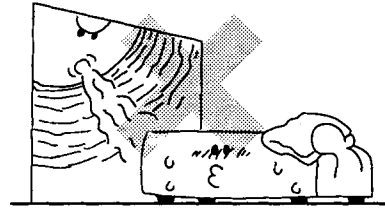

7. Power Sources - This product should be connected to a power supply only of the type described in these operating instructions, or as marked on the unit.

8. Power Cord Protection - Power supply cords should be routed so that they are not likely to be walked upon or pinched by items placed on or against them. When removing the cord from a power outlet be sure to remove it by holding the plug attachment and not by pulling on the cord.



9. Object and Liquid Entry - Take care that objects do not fall into and that liquids are not spilled into the inside of the mixer.

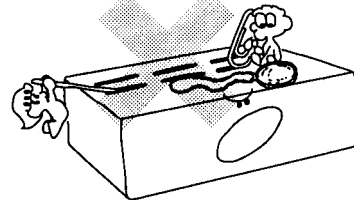

10. Damage Requiring Service - This product should be serviced only by qualified personnel. If you have any questions about service please contact **Numark** at the number(s) shown on the back cover of this manual.

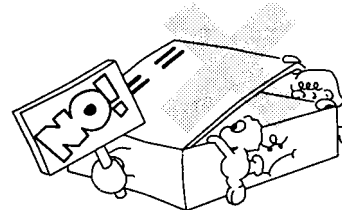

11. Grounding or Polarization - Precautions should be taken so that the grounding or polarization means built into the CD player is not defeated.

Numark - The Proven Leader in DJ Technology

Numark[®] CDN-24

PROFESSIONAL DUAL-TRANSPORT CD PLAYER WITH REMOTE CONTROLLER

CONGRATULATIONS...

You have just purchased a dual CD player designed specifically for the professional DJ. This unit has been designed to provide CD mixing with the same ease and creativity that you have enjoyed with records. Please take a few moments to familiarize yourself with the CDN-24 by reading the following information before attempting to operate the unit.

Once again, congratulations and thank you for making the CDN-24 your choice in professional CD players.

FEATURES:

- **8 times oversampling**
- **8cm single cd compatible**
- **Digital Output**
- **Interactive pitch wheel adjustment**
- **3 speed scanning**
- **Frame search**
- **Auto cue**
- **+10 tracks skip search**
- **30 tracks program play**
- **Pitch display**
- **Beat Counter**
- **Realtime Cue**

Numark - The Proven Leader in DJ Technology

TABLE OF CONTENTS

Safety and Registration	2
Introduction	4
Set-up Instructions & Connections	7
Description of the Features	
Features of the Remote Control Unit	8
Features of the Display	9
Basic Operation	
Play, Pause and Cue Operations	10
Matching the Beats Per Minute	11
Beat Matching Using Pitch Bend	12
Example of Mixing with the CDN-24	13
Before Switching off the Power	14
Troubleshooting Guide	14
Information and Specifications	15
Warranty	16

CHECK TO BE SURE

THE FOLLOWING ITEMS ARE IN THIS BOX:

- 1) DUAL-TRANSPORT PLAYER UNIT
- 1) REMOTE CONTROL UNIT
- 1) OWNERS MANUAL (THIS BOOKLET)
- 2) RCA CONNECTING CABLES
- 2) CONTROL CABLES
- 1) IEC POWER CORD

CONNECTIONS

Typical connection with a mixer is illustrated right. Please use it for reference.

- Connect the output connection cords from the CD Player to the line inputs of your mixer.
- Connect the remote control connection cable from the Unit 1 connector on the main unit to the Unit 1 connector on the remote control unit. Repeat for Unit 2.
- The output connection cords and the remote control connection cables are supplied with the main unit. Be sure to use the remote control connection cables which have been supplied. Use of another cable type might cause damage.

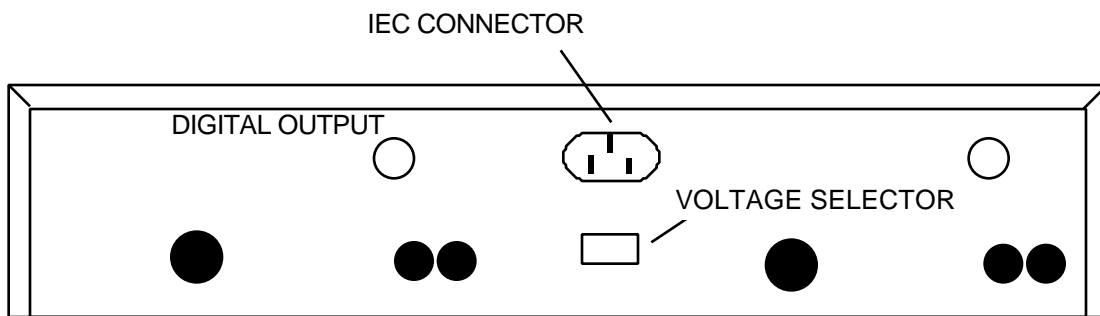
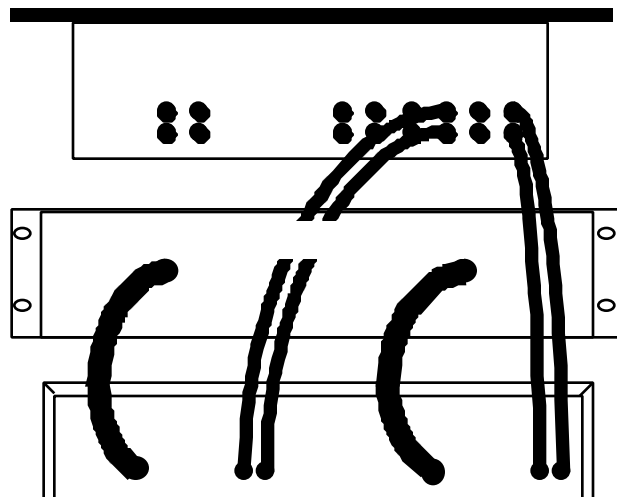

POWER ATTACHMENT: Your CD player is equipped an IEC style power connector. Please first select the proper voltage for your location. Next, plug in you supplied power cable into the rear of the unit then plug into the appropriate power outlet

DIGITAL OUTPUTS: This CD player is specially equipped with digital outputs. The format is type 2, form 1, also known as S/PDIF (Sony/Phillips Digital Interface Format). **In order to use the digital output you must be sure not to vary the pitch in any way.** To ensure this, press the pitch button to deactivate the variable pitch slider and don't use the pitch bend buttons or pitch wheel. If you adjust the pitch, other devices will not read the digital output properly.

MOUNTING YOUR CD PLAYER

- Mount the units in your console or rack with 19" EIA rails
- The transport should be mounted not to exceed an angle of 15 degrees.
- Your CD player can be affected by excess vibration so mount the units in a secure environment if possible.

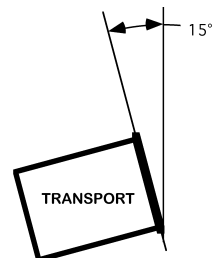

Numark - The Proven Leader in DJ Technology

DESCRIPTION CDN-24 REMOTE FEATURES

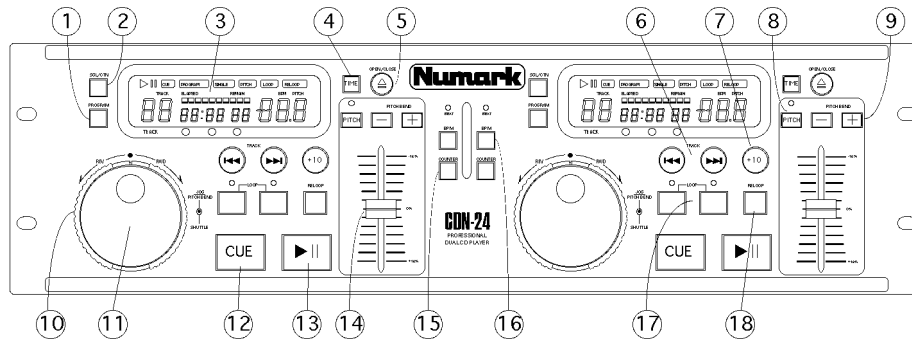

- 1. PROGRAM** - Depress this button and the unit will stop and program will be indicated on the display. Select each track to be programmed and press the PROGRAM button between selections. You can program up to 30 tracks. Press PLAY to start the program. To exit and erase program hold the program button down for more than 2 seconds while the unit is stopped, open the disc tray, or turn off the power.
- 2. CONT/SING** - Will cause just a single track to play or all tracks in order by pressing once or twice.
- 3. LCD DISPLAY** - Indicates all the functions, as they are occurring, with the CD. These functions are explained in the next section.
- 4. TIME (Time Button)** - The TIME button switches the time display between elapsed playing time and remaining time on the track.
- 5. OPEN/CLOSE (Disc Tray Open/Close)** - Press to load or eject the disc. Each press will open or close the disc tray on the transport. NOTE: Tray will not open unless the disc has been paused.
- 6. TRACK (Track Buttons)** - These buttons are used to select the track to be played.
- 7. Track 10 Button** - This button is for quickly advancing to higher tracks on a CD.
- 8. PITCH (Pitch Button)** - This button activates the Pitch Slider (14).
- 9. PITCH BEND (Pitch Bend Button)** - When each of the two CD players is playing a CD, the pitch bend function allows the positioning of the bass beats to be matched after the pitch of each disc is matched. Either player can "catch up" or "fall back" to match the other player. The pitch will automatically rise while the + button is pressed (allowing "catch up") and return to the original pitch when the button is released. The pitch will automatically drop while the - button is pressed (allowing "fall back") and return to the original pitch when the button is released. By changing the pitch of one disc with respect to the other in this way the beats can be matched.

- 10. SEARCH WHEEL (OUTER RING)** - This wheel has 3 forward and 3 reverse speed positions for searching through songs. The more you turn the wheel in either direction the faster you search through the music.
- 11. JOG WHEEL (INNER RING)** - This jog wheel serves 2 functions depending on the mode you are working in.
 - a. The jog wheel will act as a slow frame search control when the CD is not playing but either paused or set to a cue point. To set a new frame cue point, spin the wheel then press play when you have determined the proper position. Press CUE to return to the "CUE POINT".
 - b. The jog wheel will temporarily bend the pitch of the music if the song is already playing by rotating the wheel clockwise to speed up or counterclockwise to slow down.
- 12. CUE** - Pressing the CUE button during play provides a return to the position at which play was started. If PAUSE is used before CUE, that will become the cue point. Alternately pressing the PLAY button and the CUE button allows the CD to be played from the same position any number of times. The CUE LED will light up from the time the CUE button is pressed until the CD has reset to the position at which play was started. Steady lighting of this LED indicates the ready condition.
- 13. START/PAUSE (Play/Pause Button)** - Each press of the Play/Pause Button causes the operation to change from play to pause or from pause to play.
- 14. PITCH SLIDER** - The pitch can be changed up to +/-12% by pressing the PITCH button so the PITCH LED is lit, then moving the sliding fader. The pitch will not be changed if the PITCH LED is off.
- 15. COUNTER BUTTON** - Tap this button with the beat of the music to determine the current Beats Per Minute (BPM).
- 16. BPM BUTTON** - Switches the mode of the display between showing the BPM and the percentage change in pitch.
- 17. LOOP BUTTON** - Used for repeating sections in the music. This is not a seamless function.
- 18. RELOOP BUTTON** - For repeating the loop.

Numark - The Proven Leader in DJ Technology

LCD DISPLAY FEATURES

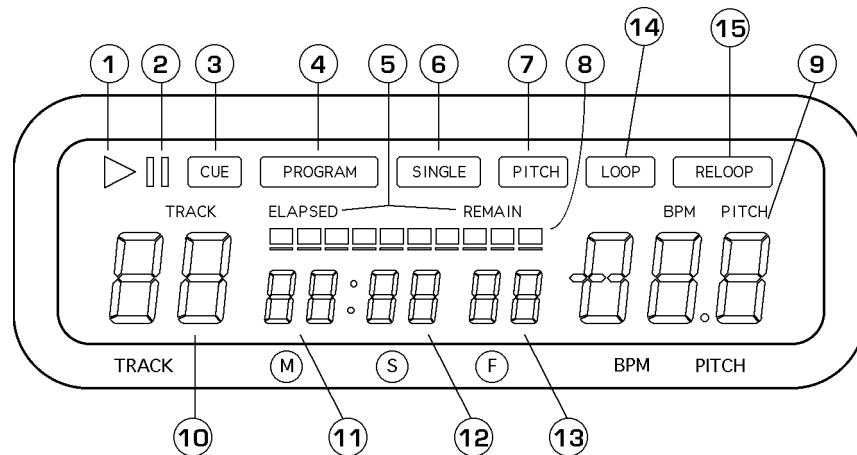

1. PLAY - Active while the unit is actually playing a CD.

2. PAUSE - Active when the unit is paused.

3. CUE - Flashing when the unit is setting a cue point. Lit continuously when the unit is paused at a cue point.

4. PROGRAM - used for preprogramming the track order to automatically be played by the unit. This is a great function if you need leave the CD player alone.

5. TIME MODE -

(Elapsed) is for showing time as it is taking place.

(Remain) shows how much time is left on a particular track. This function is controlled by the **TIME BUTTON (4)**.

6. SINGLE - Shows when the unit is set to play just one track at a time. When this is not lit the CD will play continuously through all tracks. This function is controlled by the **SING/CONT BUTTON (2)**.

7. PITCH - is lit when the display is showing.

8. TIME BAR - shows either time remaining or elapsed depending on the setting of the **TIME BUTTON (4)**.

9. PITCH/BPM - Shows either the percentage change in pitch or the BPM of the song depending on the mode selected with the **BPM BUTTON (16)**.

10. TRACK - shows the track that the unit is playing with.

11. MINUTES - shows the minutes elapsed or remaining depending on mode setting.

12. SECONDS - shows the seconds elapsed or remaining depending on mode setting.

13. FRAMES - The CD Player breaks down a second into 75 frames for accurate cueing. This shows the frames elapsed or remaining depending on mode setting.

14. LOOP - shows when the CD is repeating a particular area with the music on the CD.

15. RELOOP - shows when the CD has had a loop set previously and can go back to it to loop again.

DESCRIPTION OF THE PLAY/PAUSE AND CUE OPERATIONS

PLAY and CUE

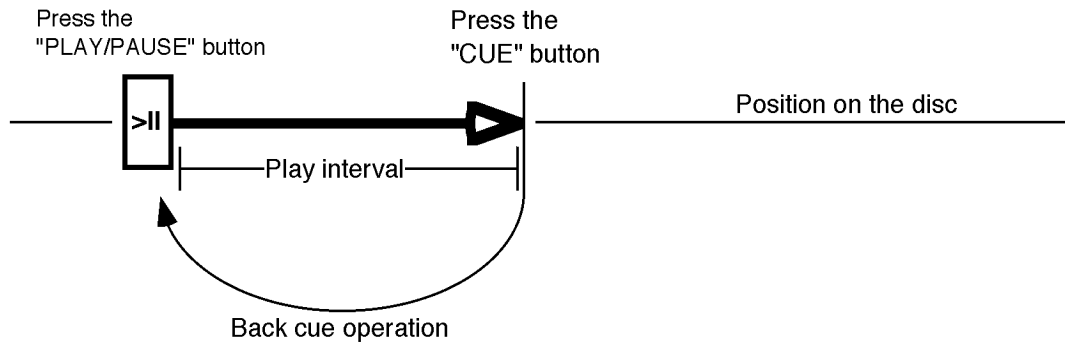

Pressing the "PLAY/PAUSE" button starts the disc. Pressing the "CUE" button will reset the disc to the last place where the disc was started. This is called the cue point. By alternately pressing the "PLAY/PAUSE" button and the "CUE" button, the disc may be returned and played from the cue point any number of times. This function is called back cue.

PLAY, PAUSE and CUE

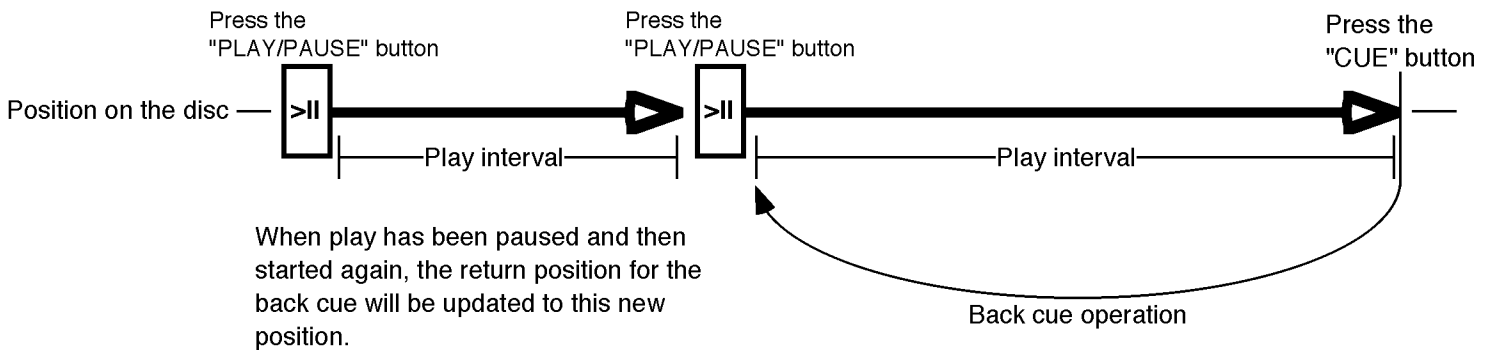

EDITING CUE POINT

When the inner search dial is turned while a cue point is set, a new cue point can be located. The CD player will repeatedly play small parts of the CD as you move it to the desired position. By pressing "PLAY/PAUSE" then "CUE" you can confirm this new cue point is desirable.

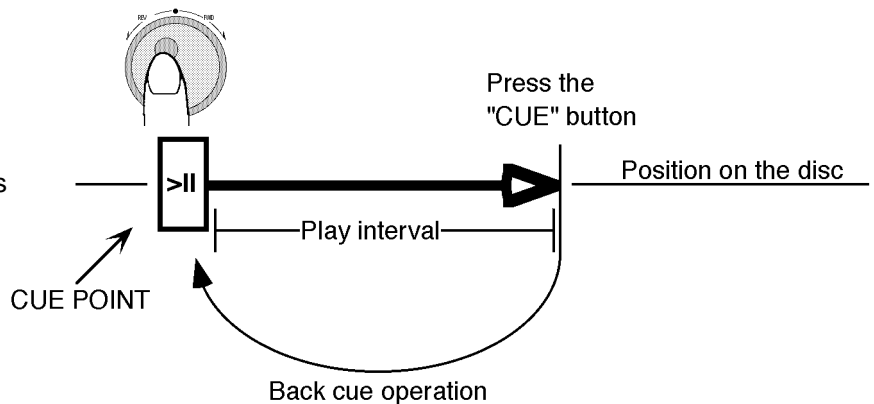

MATCHING THE BEATS PER MINUTE (BPM)

Match the tempo by monitoring the music of both PLAYER 1 and PLAYER 2 by ear and adjusting the pitch. With the CDN-24 you also have the option of using the BPM display as explained below. When the tempo of the music of the selected CD player is slow compared to the tempo of the other player, move the slider to the (+) side and match the tempo. When faster, move the pitch slider to the (-) side. The following description is for the case of matching the pitch of PLAYER 2 to the pitch of the music being played on PLAYER 1.

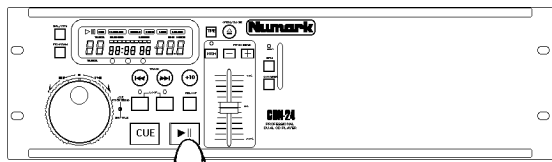

Press PLAY/PAUSE to start PLAYER 1
PLAYER 1 is playing

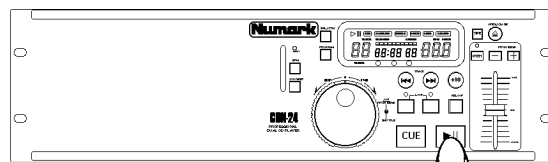

Press PLAY/PAUSE to start PLAYER 2
Both CD players are playing discs.

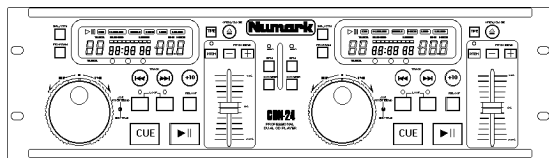

Listen to PLAYER 2 in your headphones and
look at the BPM display information

When PLAYER 2 is slow compared to
PLAYER 1
speed up PLAYER 2

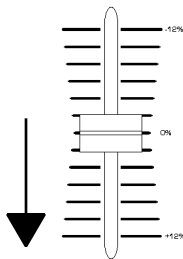

When PLAYER 2 is fast
compared to PLAYER 1
slow down PLAYER 2

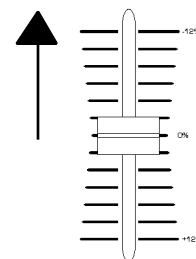

USING THE BPM DISPLAY FEATURE

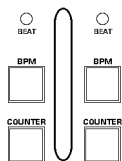

Press the BPM button to select the BPM feature
on the display on the side of the
CD player that you wish to set.
Tap the Counter button to the beat of the music.

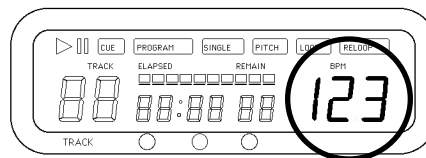

You will see the BPM number appear in the display.
The more times you tap the more accurate your number will
be. When you adjust the pitch slider the display number will
change by an equal percentage .

BEAT MATCHING USING PITCH BEND

BPM's (Beats Per Minute) are the same, however, the drum beats are not matched



A description of the procedure for matching the beat of PLAYER 1 and PLAYER 2 using the PITCH BEND button. This description is for the case of matching the beat of PLAYER 2 to the beat of the music being played on PLAYER 1. (This procedure can be done on either PLAYER).

After Matching the BPM's adjust the pitch temporarily as follows:

When PLAYER 2 is ahead press the  or rotate the jog wheel counter clockwise

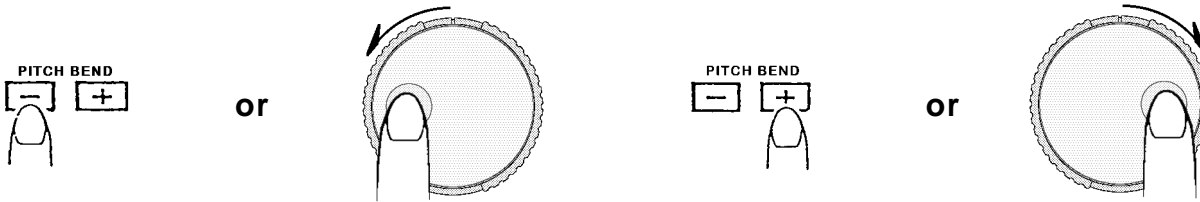
When PLAYER 2 is behind press the  or rotate the jog wheel clockwise



The pitch changes automatically while the  or  button is being pressed or the jog wheel is rotated. The faster you rotate the wheel the more you change. Releasing the button or wheel results in a return to the original pitch. (So the BPM's are once again the same.)

USING THE LOOP

This function is repeating certain areas of the CD. Such as vocal stabs or for allowing the beginning of a song repeat itself so you may leave the DJ console and interact directly with your crowd

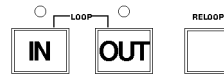

There are 3 button associated with the loop feature.

IN, OUT and RELOOP

You notice the "LOOP IN" in button LED will be lit up as soon as a track is cued up. This means that the initial cue point of the CD also becomes the default start point for a loop. If you wish to set a new "LOOP IN" point just press the button while the CD is playing when it reaches the desired point.

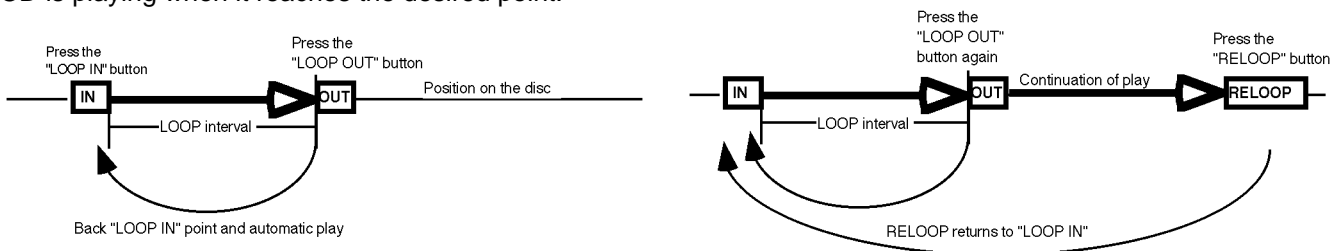

The "LOOP OUT" determines the end point for a loop. The first time you press this button while a CD is in play mode, the song automatically returns to the "LOOP IN" point and starts to play. Looping is not seamless on this unit. When it reaches the "LOOP OUT" point again it returns to the "LOOP IN" point and continues to repeat this action. When the "LOOP OUT" point is pressed again the CD will continue on when it gets to this point.

The "RELOOP" button automatically causes the set loop to be played again until it is released with the "LOOP OUT" or "RELOOP" button.

EXAMPLE OF MIXING USING BOTH PLAYERS OF THE CDN24

While playing a disc on PLAYER 1 load a disc into PLAYER 2 and select your next track, match its pitch to the track playing on PLAYER1 and when you are ready use the crossfader on your mixer to fade from PLAYER 1 to PLAYER 2.

Load a disc in PLAYER 1 and select the track and press PLAY.

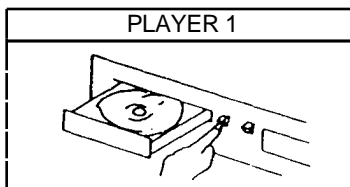

Load a disc and press the OPEN/CLOSE button.



Select the track to be played.

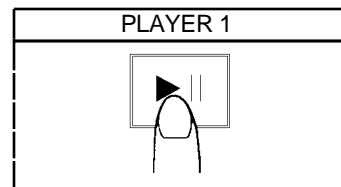

Press the PLAY button

Load a disc in PLAYER 2 and select the track then play.

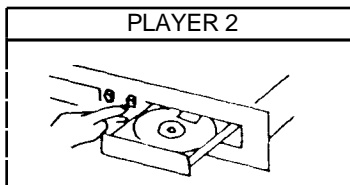

Load a disc and press the OPEN/CLOSE button.



Select the track to be played.

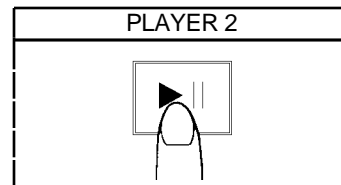

Press the PLAY button

Set and edit a start cue point on PLAYER 2

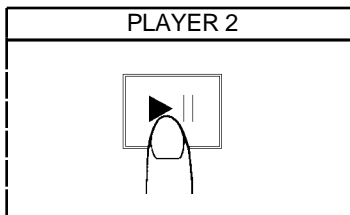

Press the Pause button of PLAYER 2.

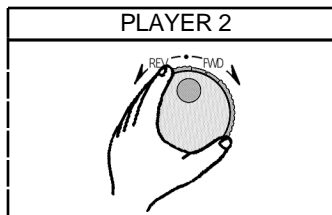

Rapidly search for a cue point using the outer wheel

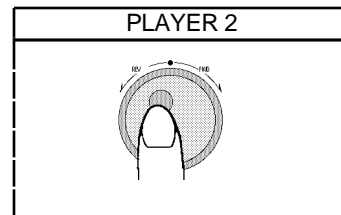

Slowly set the right point using the inner wheel

Check you new cue point

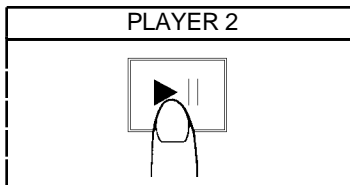

Listen with the monitor and press the play button.

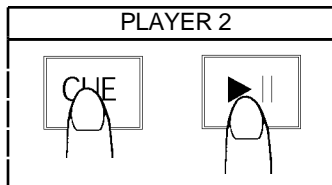

Press the cue button then play to be sure of the set cue point.

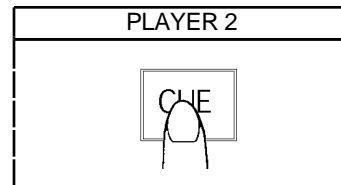

Set the player to the Cue point by pressing Cue

Do a MIX!

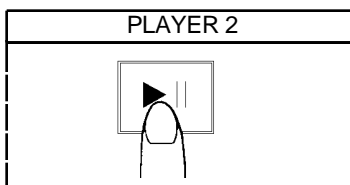

With a matching downbeat from Player 1 press the play button.

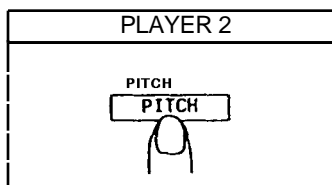

If you are beat mixing turn on your Pitch adjust and follow the directions for beat matching.

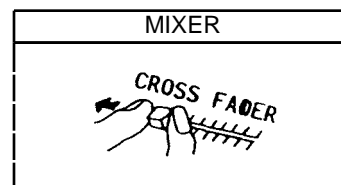

When you are happy with you mix adjust you mixer accordingly.

BEFORE SWITCHING OFF THE POWER:

When you have finished using the CD player, be sure that the disc tray is closed with the "OPEN/CLOSE" button before switching off the power .

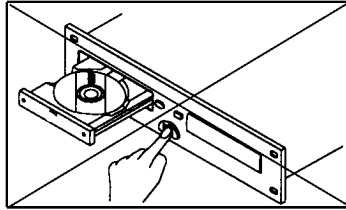

DO NOT switch off the power when the disc holder is open.

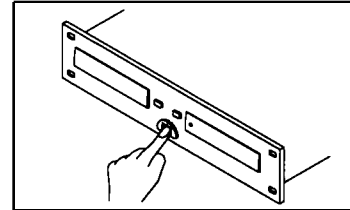

Switch off the power **after** the disc holder has been closed with the "OPEN/CLOSE" button

Troubleshooting Guide

Symptom	Possible Cause	Corrective Action
The power fails to switch on when the POWER switch is set to on	Poor power plug connection at the AC outlet	Insert the power plug firmly into the AC outlet
Disc play does not start	The disc is loaded upside down The disc is too dirty	Reload the disc with the label side up Clean the disc
No sound	Improper output cable connections Improper amplifier operation	Connect the output cables correctly Check amplifier setup
Sound skips	The CD player is subject to vibrations or physical shock The disc is too dirty	Change the installation location Clean the disc
Programmed disc play will not function	The CD player is in normal disk play mode	Hold down the Program button for 3 seconds then program the tracks
Hum	Loose cable connections	Firmly connect all audio plugs

SPECIFICATIONS

GENERAL

Dimensions:	Main Unit:	482 (W) x 88.8 (H) x 264 (D) mm (without feet) 19 (W) x 3.5 (H) x 10 3/8 (D) inches (without feet)
	Control Unit:	482 (W) x 132 (H) x 74 (D) mm (without feet) 19 (W) x 5 1/4 (H) x 2 7/8 (D) inches (without feet)
Weight:	Player Unit:	5 Kgs, 11 lbs
	Control Unit:	2 Kgs, 4.4 lbs
Power Supply:		115/230V AC, 50/60Hz
Power Consumption:		25W

Numark[®]

Professional Disc Jockey Products

Warranty and Service Information

Numark Industries, LLC and Numark International, Inc. (hereafter "Numark") warrants each new product manufactured and/or supplied by it to be free from defects in material or workmanship under conditions of normal use and service for 360 days, beginning on the date of purchase from an authorized Numark Dealer, but not to exceed 2 years from date of shipment by Numark.

The Numark obligation under this warranty is limited to repairing or replacing, at its option, the product or part(s) therein; which upon examination by Numark shall appear to be defective or not up to factory specifications; providing the Numark product is returned (transportation prepaid) to Numark.

Numark shall not be liable for any damages, consequential or otherwise, resulting from the use and operation of this product and makes no other warranty(s) either express or implied on this product, including any warranty of merchantability.

This warranty does not extend to any of our products which have been subjected to misuse, neglect, accident, incorrect wiring not our own, improper installation, or use in violation of instructions furnished by us, nor extended to units which have been repaired or altered outside of our factory, nor to cases where the serial number thereof has been removed, defaced, or changed, nor to accessories used therewith not of our own manufacture. Numark reserves the right to make changes or improvements in its products, during subsequent production, without incurring the obligation to install such changes or improvements on previously manufactured equipment.

To place this warranty into effect, the enclosed WARRANTY REGISTRATION CARD must be returned to Numark Industries, LLC within thirty (30) days after date of purchase.

This warranty gives you specific legal rights, and you may also have other rights which vary from state to state.

Some states do not allow the exclusion or limitation of incidental or consequential damages so the above limitation or exclusion may not apply to you.

EQUIPMENT TRANSPORT

A Return Authorization number should be obtained from Numark through the addresses or phone numbers below.

It is the customer's obligation, when returning faulty equipment, to properly pack the Numark equipment in its original packaging. Failure to do so may inadequately protect the equipment in transit and, therefore, jeopardize the customer's warranty. The defective Numark equipment should be sent, FREIGHT PREPAID with Return Authorization number to:

NUMARK INDUSTRIES
11 Helmsman Road
North Kingstown, RI 02852 U.S.A.
Attention: Service Department

Telephone: +1 (401) 295-9000
Fax: +1 (401) 295-5200
E-mail: numark@numark.com